



RUGGED

INSTRUCTION MANUAL AND PARTS GUIDE

CAUTION Read the instruction manual before using the machine

D'Lite

Commercial *Backpack*
Vacuum Cleaner with
HEPA Filtration
Model No.:15721100



Rugged Industries Pty Ltd

ABN: 59 154 866 878

12 / 51 Owen Street

Glendenning NSW 2761 Australia

Postal: PO Box 1076 Dundas NSW 2117

Ph: +61 2 9680 0052

Email: contactus@ruggedindustries.com.au

www: ruggedindustries.com.au

Safety Instructions

Read this manual before using the back pack and always follow the Safety and Maintenance Instructions

CAUTION: This machine shall be stored indoors only

- **This machine is intended for domestic and commercial use only**
- Do not leave the appliance when plugged in. Unplug from the power point when not in use and before servicing.
- Do not use outdoors or on wet surfaces.
- For domestic use:
 - The appliance is not intended for use by persons (including children) with reduced physical, sensory or mental capabilities, or lack of experience and knowledge, unless they have been given supervision or instruction concerning use of the appliance by a person responsible for their safety
- For commercial use:
 - The appliance is not intended for use by persons (including children) with reduced physical, sensory or mental capabilities, or lack of experience and knowledge
- Children should be supervised to ensure that they do not play with the appliance.
- Use only as described in this manual. If appliance is not working as it should, has been dropped, damaged, left outdoors, or dropped into water, return it to a service centre.
- Extension Cord **MUST** be secured by the relief retainer in the side of the vacuum cleaner
- Do not pull or carry by cord or plug, use cord as a handle, close a door on cord, or pull cord around sharp edges or corners. Do not run appliance over cord. Keep cord away from heated surfaces.
- If the cord is damaged, it must be replaced by the manufacturer or its service agent or a similarly qualified person in order to avoid a hazard.
- Do not unplug by pulling on cord. To unplug, grasp the plug, not the cord.
- Do not handle plug or appliance with wet hands.
- Do not put any object into openings. Do not use with any opening blocked.
- Keep hair, loose clothing, fingers and all parts of body away from openings and moving parts.
- Turn off all controls before unplugging.
- Use extra care when cleaning stairs.
- Do not use to pick up flammable or combustible liquids, such as petrol, or use in areas where they may be present.
- A locally approved optional electric power brush shall only be connected to the power outlet. (Max Load:200w)

WARNINGS

Do Not

- Do not vacuum wet surfaces, damp areas or suck up water
- Do not use machine if water has been picked up by the vacuum system without an electrical inspection by a qualified person.
- Do not vacuum anything that is burning or smoking such as cigarettes, matches or hot ashes.
- Do not use the machine in areas where flammable or combustible liquids, vapours or gas are present.
- Do not operate near explosive materials such as solvents, thinners, fuels or grain dust.



SAVE THESE INSTRUCTIONS

Packaging

- Every Impress unit comes with:
- A basic set of cleaning accessories: crevice tool, dusting brush, 10 paper filter bags, and 1 spare cloth filter, vacuum hose with elbow hand grip, 2 piece wand, and EZ2GO floor tool.
- Cloth filter bag
- Motor Filter HEPA (located under cloth filter bag)

Assembly

- Connect both wands together to create one length

- **To Remove Lid**

Lift Magnetic Latch opposite side of inlet, rotate lid away from Canister body.

- **To Fit Lid**

Rotate onto canister body fitting inlet side first and align accurately. Magnetic latch will engage automatically.

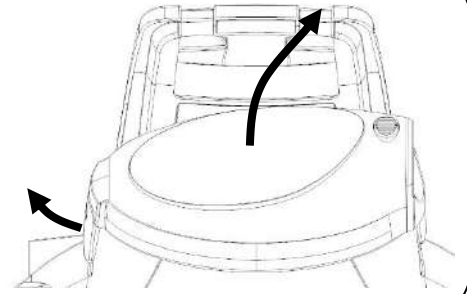

NOTE: The Lid can be fitted for either left or right operation.

- **To Remove Hose**

Press Hose Release Button, and gently pull Inlet Elbow from Lid.

- **To Fit Hose**

Insert Inlet Elbow into lid opening

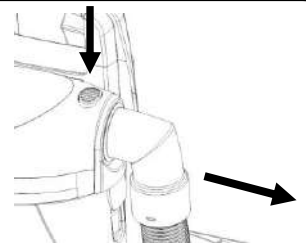

- **To Remove Filter Bag**

Lift from top of canister using bag rim.

- **To Fit Filter Bag –**

Place over canister rim and press firmly ensuring bag is level.

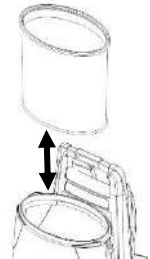

- **Removal & Disposal of Paper Bag Filter**

Ease cardboard retainer off the groove on the Inlet Spout. Fold cardboard tab over bag inlet hole to prevent spillage. Dispose into garbage bin.

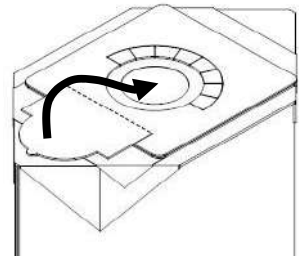

- **To Fit Paper Bag Filter**

Align paper bag cardboard, engage non-serrated portion of cardboard (A) into Inlet Spout groove. Ease the remaining serrated portion of cardboard (B) onto groove. Keep corners of paper folded down to avoid entrapment under lid edge.

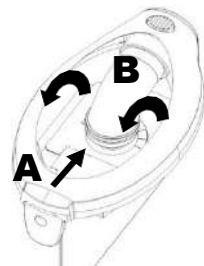

- **To Remove Motor Filter**

Use the Filter flaps to lift from canister base. Remove with care from the canister.

- **To Fit Motor Filter**

Insert into canister base filter recess. Press firmly around the edge of the filter to fit into position.

NOTE: Do not press on filter media.

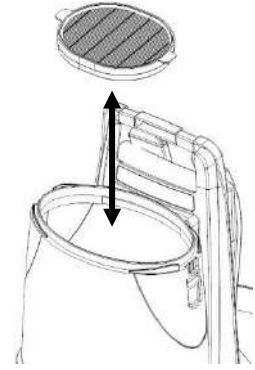

- **To Fit Cord**

To reducing tripping hazards, and for safety when unplugging, Fit the cord onto extension cord restraints on both sides of machine as shown.

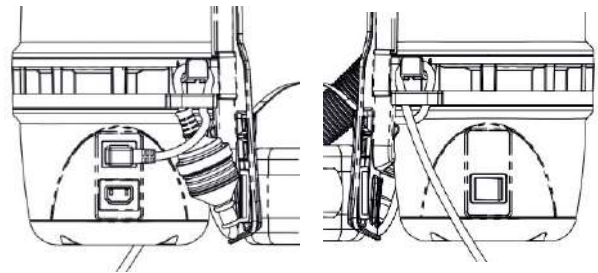

- **To Regulate Suction**

Slide the suction regulator on the Bent End Piece forward to close, this provides more air at the nozzle. Slide the regulator back for less air, this is suitable when vacuuming loose materials such as mats.

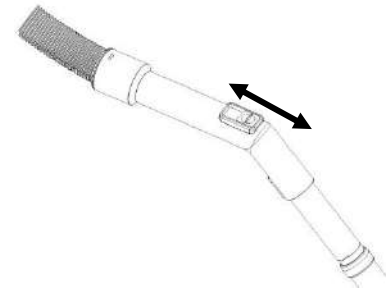

- **To Fit or Remove.**

Twist and pull to disassemble. Attach at any point from Bent End Piece to Wand end, to suit application

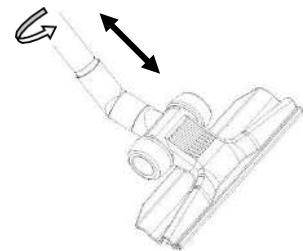

Adjustment and Wearing

- Wearing the Vacuum Cleaner**

Loosen Shoulder Pad Straps by pulling straps in the direction shown, and lift the vacuum onto the shoulder.

Position the waist-band into the 'small' of your back just above your backside.

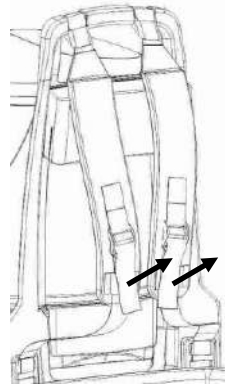

- Adjusting Waist, Shoulder and Sternum Straps**

Tighten the elasticised waist belt, overlapping the hook and loop flaps until secure and comfortable.

Pull down on the shoulder straps to tighten.

Adjust the length of the Sternum Strap to suit and snap together.

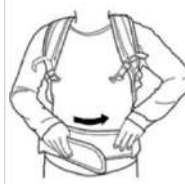

- Correct Wear**

Safety and Maintenance Checks

- Cloth Filter Bag**

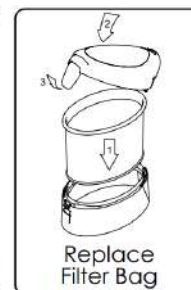
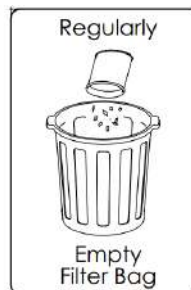

- Motor Filter**



- **As Needed**
Check Inlet Elbow, Hose, Bent End Piece and Floor Tool for blockages.

Regularly
Check cord for cuts, exposed wire, abrasion and twisting. Replace cord only with original manufacturer's part.

Note:
Always unplug cord from power point when not in use. Gather the cord by winding from the machine end.

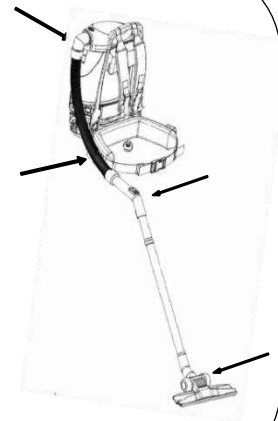
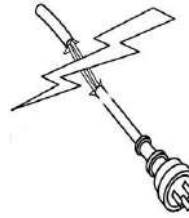

Operation

- **Using**
For comfortable operation, stand upright with a relaxed posture, arms hanging loosely to the side

Maintain a straight wrist, hold the handle grip of the Bent End Piece with one hand parallel to the floor.

When vacuuming under office desks, the reach of the wand is sufficient to avoid bending at the waist

When vacuuming under lower profile objects or when picking up items off the floor, bend the knees and maintain a straight back.

When turning, do not twist at the waist. Turn using your feet



- **Working**
Plan the work path based on location of the power point, room/furniture layout, and entrance and exit points.

Commence vacuuming using a systematic approach working one half of the area first, away from the power point, and then the other half of the area, returning back to the start.

Ensure that the power cord is clear of feet to reduce likelihood of tripping.

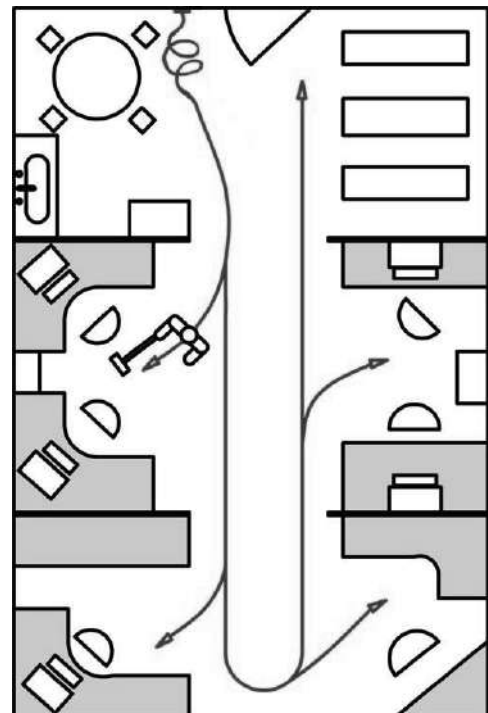

Product Specifications

General			
Packaging	Size: 36 x 36 x 54 cm Weight: 9.0 kg		
Vacuum	<table border="0"> <tr> <td>Type: Dry Class: Type 2 Double Insulated Approval: RCM</td> <td>Air Flow Nozzle: 34l/s Suction: 22 kPa Noise: 72 dBA at 1m Weight: 4.4 kg - not including cord and rod</td> </tr> </table>	Type: Dry Class: Type 2 Double Insulated Approval: RCM	Air Flow Nozzle: 34l/s Suction: 22 kPa Noise: 72 dBA at 1m Weight: 4.4 kg - not including cord and rod
Type: Dry Class: Type 2 Double Insulated Approval: RCM	Air Flow Nozzle: 34l/s Suction: 22 kPa Noise: 72 dBA at 1m Weight: 4.4 kg - not including cord and rod		
Filtration			
Cloth Filter Bag	Size: 5 Litre, Antimicrobial polyester needle felt.		
Paper Filter Bag	Size: 5 Litre, Rubber membrane sealed cardboard reinforced paper bag.		
Motor Pre-Filter	Type: Polyester Pleated Filter Class: H10 HEPA		
Electrical			
Power Supply	220 - 240V.a.c., 50 Hz		
Power Outlet	2 Pin IEC		
Total Power	1500W		
Electrical Cord	18 m, 10 A, 3 core ordinary duty		
Thermal Protection	110°C auto-reset thermostat		
Motor			
Vacuum Motor	Type: Rated 1300w, Eco Single Turbine Flow Through Output Performance: Air flow 42.0 l/s, Suction 27.2kPa, Air Watts 450 Carbon Brush Life: 700h		
Warranty	2 year Body, 2 year Motor		
Sound level	72 dB(A) Noise level average		
Accessories	<table border="0"> <tr> <td>1 x 32mm EZ2GO Floor Tool with rubber tread 1 x 32mm Crevice Tool 10 Paper Bag Filters 1 x 32mm Dusting Brush 32mm Crevice Tool</td> <td>1 x 5 Litre Spare Antimicrobial cloth Bag 1 x 32mm x 1.2m "Crush Proof" Antimicrobial Hose 2 x 495L Corrosion Resistant Stainless-Steel Rods</td> </tr> </table>	1 x 32mm EZ2GO Floor Tool with rubber tread 1 x 32mm Crevice Tool 10 Paper Bag Filters 1 x 32mm Dusting Brush 32mm Crevice Tool	1 x 5 Litre Spare Antimicrobial cloth Bag 1 x 32mm x 1.2m "Crush Proof" Antimicrobial Hose 2 x 495L Corrosion Resistant Stainless-Steel Rods
1 x 32mm EZ2GO Floor Tool with rubber tread 1 x 32mm Crevice Tool 10 Paper Bag Filters 1 x 32mm Dusting Brush 32mm Crevice Tool	1 x 5 Litre Spare Antimicrobial cloth Bag 1 x 32mm x 1.2m "Crush Proof" Antimicrobial Hose 2 x 495L Corrosion Resistant Stainless-Steel Rods		

Please note specifications can change without notice.

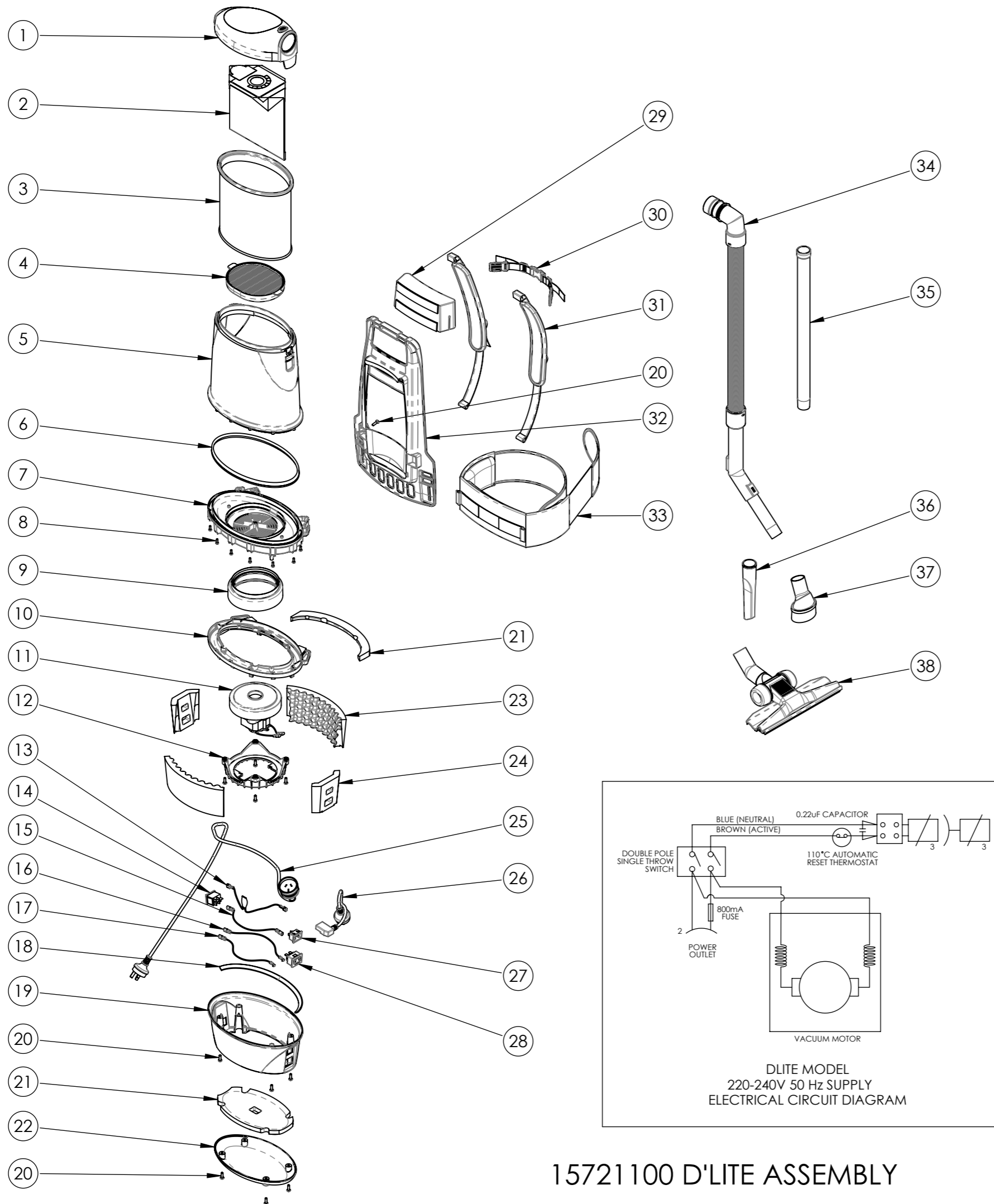

Item	Part Number & Description	Qty.
1	13717003 Lid BVC DGrey Assy	1
	13610009 Button Release BVC Black	1
	13710001 Lid View Lens	1
	13710004 Lid Spout	1
	13710021 Latch with Magnet Black	1
	13750001 Pin Latch	1
	13780010 Spring Release	1
	13790005 Trim Lid DGrey	1
2	13657006 Filter Bag Paper 5L 5/Pkt. Std.	2
3	13657001 Filter Bag Assy 5L AB Std.	1
4	13657003 Filter VFD Assy	1
5	13677001 Housing Upper Canister Assy	1
6	13780004 Seal Canister Housing	1
7	13610003 Base Upper Canister	1
8	13780002 Screw WN1412 KB40 x 12 ZP	12
9	13780006 Seal Motor Harbin	1
10	13610004 Baffle Motor Housing	1
11	13727002 Motor Vacuum Harbin 240V	1
12	13620005 Clamp Motor	1
13	13827001 Wire Thermostat Assy 4L & 5L BVC	1
14	13780014 Switch Rocker 2HP	1
15	13820002 Wire N 240V Inlet-Switch 4L & 5L BVC	1
16	13820003 Wire N 240V Switch-PO 4L & 5L BVC	1
17	13657011 Fuse Link 4L & 5L BVC	1
18	13780005 Foam Seal (Upper Baffle)	1
19	13670004 Housing Canister Lower In Out and Sw	1
20	13780003 Screw WN1412 KB50 x 16 ZP	14
21	13680003 Insulation End Cap (Set)	1
22	13620022 Cap Motor Housing BVC LGrey	1
23	13680002 Insulation Motor Housing Side (Set)	1
24	13680001 Insulation Motor Housing End (Set)	1
25	16002004 Cord Extension 18m Orange	1
26	13620009 Cord Coupling IEC - 4L & 5L BVC	1
27	13780007 Socket Inlet C14	1
28	13780008 Ssocket Outlet C18	1
29	13750003 Pad Back BVC	1
30	16018025 Strap Sternum with Adjuster and Buckle	1
31	13750006 Pad Shoulder BVC 4 Piece Set	1
32	13650002 Frame BVC DGrey	1
33	13750007 Pad Waist BVC	1
34	13677006 Hose AB BEP & Elbow 4L & 5L Assy	1
	13647001 Elbow Inlet BVC	1
	13647002 Elbow BEP 32mm Black	1
35	16022005 Rod Stainless 32mm x 495L	2
36	16019002 Tool Crevice	1
37	16019003 Tool Dusting Brush	1
38	16019004 Tool Floor E2ZGO	1

15721100 D'LITE ASSEMBLY



OPTIONAL ACCESSORIES			
ITEM NO.	PART NUMBER	DESCRIPTION	QTY
1	16019005	Tool Turbo Brush 32mm	1
2	16019006	Tool Combination 32mm x 300mm Wide	1
3	16019014	Tool Mega Gulper Pro 32mm x 385mm Wide	1
4	16019007	Tool Upholstery 32mm	1
5	16019017	Tool Electric Brush 32mm x 355mm Wide	1
6	16019016	Tool Hard Floor 32mm x 360mm Wide	1

D'LITE ACCESSORIES

Trouble Shooting

Always switch off D'Lite and unplug from wall prior to correcting any problems. If you are unable to rectify the problem, contact your local service agent.

Problem: Machine not working	
Cause	No power at power point.
Solution	Connect machine to a functional power point.
Cause	Power cord not plugged into power point or machine.
Solution	Check plug is firmly plugged into a power point and machine.
Cause	Machine or power supply not switched on.
Solution	Turn on/off switch to ON (I). Turn power supply outlet on.
Cause	Machine has switched off due to overheating.
Solution	Switch off and unplug machine. Check for any blockages in wand, floor tool and inlets. Ensure filters and paper and cloth bags are clean. Wait for 30 minutes and switch machine back on. If machine does not start up, contact service agent.
Problem: Poor or No Suction	
Cause	Blockage.
Solution	Turn off machine and unplug. Check wand, suction hose, floor tool, elbow inlets for obstructions and remove.
Cause	Paper or Cloth Filter Bags are full.
Solution	Check paper bag and if full, remove and replace. Check Cloth Filter Bag, turn inside out and brush with a soft banister brush before replacing.
Cause	Hose not installed properly or damaged.
Solution	Check hose connection and ensure it is locked in. Replace if damaged.
Cause	Motor Filter is blocked.
Solution	Remove Secondary Filter and tap gently to remove excess dust before replacing.
Cause	Air Regulator needs adjustment.
Solution	Adjust Air Regulator on hose to obtain suction required.
Problem: Uncomfortable to Wear	
Cause	Backpack is not fitted correctly to your body.
Solution	Adjust waist and shoulder pad as described on page 5 to ensure correct fit.
Cause	Pads or straps are worn.
Solution	Replace padding/straps.

General Warranty Policy

Rugged Industries Pty Ltd ACN 154 866 878 (“Rugged”) warrants to the original purchaser that the equipment specified in this manual (“Equipment”) is free from defects in workmanship and materials under normal use for a period of 12 months.

Under this warranty, after examination discloses it to have been defective, Rugged will repair or replace at its factory or authorised dealer service outlet, parts of the Equipment that fail under normal use and service, when operated and maintained in accordance with the applicable operation and instruction manuals.

All warranty claims must be submitted via the Rugged-authorized dealer or service agent the item was purchased. The purchaser is responsible to return the defective goods at their expense, to the Rugged-authorized dealer or service agent the item was purchased from.

This warranty does not apply to components replaced due to recommended service schedules, normal wear and tear or to items whose life is dependent on their use and care.

Use of replacement parts not manufactured or supplied by Rugged will void all warranties expressed or implied and may give rise to a potential health hazard. All parts replaced under this warranty become the sole property of Rugged or its original manufacturer, whichever the case may be.

This warranty is applicable only to the original purchaser. Rugged is not responsible for costs or repairs performed by persons other than those specifically authorised by Rugged. This warranty does not apply to damage from transportation, alterations by unauthorised persons, misuse or abuse of the equipment, use of non-compatible parts, or damage to property, or loss of income due to malfunction of the Equipment. If a difficulty develops with this Equipment, you should contact the dealer from whom it was originally purchased.

The warranty coverage period on Equipment will commence 1 year after the date of shipment from Rugged to its dealer or authorised agent unless the Equipment is sold before this time. This sale date would then be the beginning date of the warranty coverage.

The following statements only apply to a consumer sale of goods or services as defined in the Australian Consumer Law. In this statement, ‘Our’ means ‘Rugged’ and ‘you’ means ‘original purchaser’:

Our goods come with guarantees that cannot be excluded under the Australian Consumer Law. You are entitled to a replacement or refund for a major failure and for compensation for any other reasonably foreseeable loss or damage. You are also entitled to have the goods repaired or replaced if the goods fail to be of acceptable quality and the failure does not amount to a major failure.

To the extent permitted by law, all other warranties whether implied or otherwise, not set out in these warranty terms and conditions are excluded and Rugged is not liable in contract, tort (including, without limitation, negligence or breach of statutory duty) or otherwise to compensate you for:

- any increased costs or expenses;
- any loss of profit, revenue, business, contracts or anticipated savings;
- any loss or expense resulting from a claim by a third party; or
- any special, indirect or consequential loss or damage of any nature whatsoever caused by Rugged’s failure in complying with its obligations

The benefits given to you in this warranty are in addition to other rights and remedies under a law in relation to the Equipment or services to which this warranty applies.

Warranty Registration Details

Purchaser:.....Purchase date:.....

Address:.....

State:.....Post Code:.....Contact:.....ph:

Model No.:.....Serial Number:.....

Purchased from:.....

Address:.....

Please attach copy of receipt.



Rugged Industries Pty Ltd

ABN: 59 154 866 878

12 / 51 Owen Street

Glendenning NSW 2761 Australia

Postal: PO Box 1076 Dundas NSW 2117

Ph: +61 2 9680 0052

Email: contactus@ruggedindustries.com.au

www: ruggedindustries.com.au